

**Kazma<sup>TM</sup> plus**  
WORLD OF ARCHITECTURAL INNOVATION

# ARCHITECTURAL GLASS HARDWARE

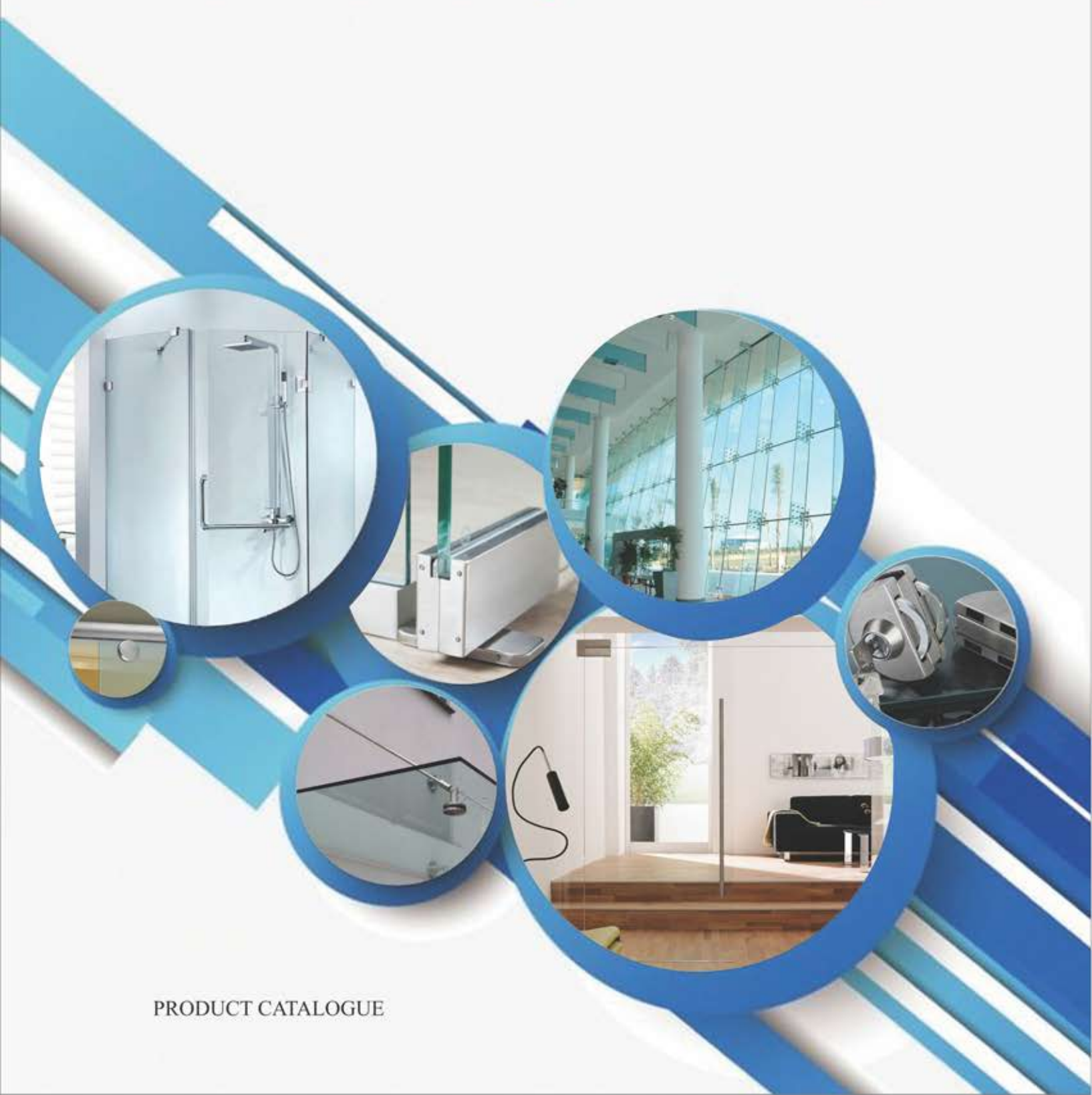

PRODUCT CATALOGUE



Kazma Plus mixed up innovation, constant improvement and perfection to get itself in the top slot of the severe market competition.

Relying on outstanding talent, advanced technical facilities and perfect quality management system, we have made every product excellent in function, shape and quality.

Kazma Plus is diligent and dedicated. Looking into the future we will continue to take market as guide, introducing new technologies and developing new products.

These are our action plans for our pre set goals. We believe in continuous motivation for the people who are with us.

In short that is how our success is born... and will continue only with the extreme support of our costumers.

We follow stringent quality checking methods and abide by international standard. Regular up gradation of quality standard ensures that all products leaving our premises are up to the quality specification of the market.

Our quality management system comprises os several inspection procedures throughout the manufacturing process. Every product is manufactured by employing the finest quality of raw material. We want ti give you the best with better quality and services.





# Table of Contents

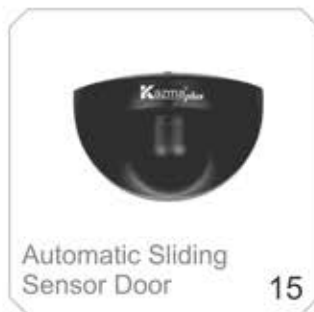



**KZHFS-100**  
Hydraulic Floor Spring

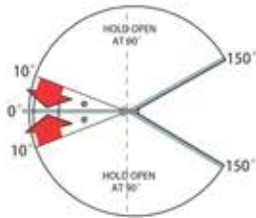

**Product Specification**

- Suitable door weight : Max 80kg
- Suitable door width : 750-1000mm
- Suitable door thickness : 12mm
- Ambient temperature : -20°C~+50°C
- Quick and easy installation

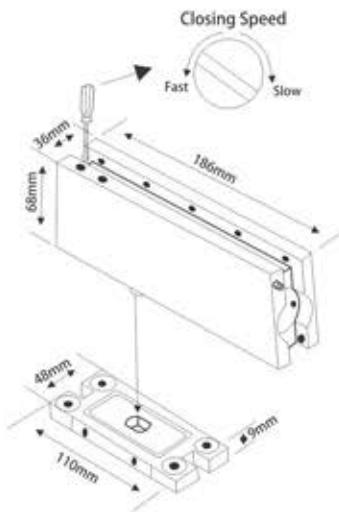

## Door Closer



**KZDC-1**  
Door Closer  
Specification  
• Applicable Door Weight up to 70 kg.  
• Finish : Aluminium and SS



**KZDC-2**  
Door Closer  
Specification  
• Applicable Door Weight up to 70 kg.  
• Finish : Aluminium and SS



**KZDC-3**  
Door Closer  
Specification  
• Applicable Door Weight up to 90 kg.  
• Finish : Aluminium and SS



**KZDC-3**  
Door Closer (with Pelmet Arm)  
Specification  
• Applicable Door Weight up to 90 kg.  
• Finish : Aluminium and SS

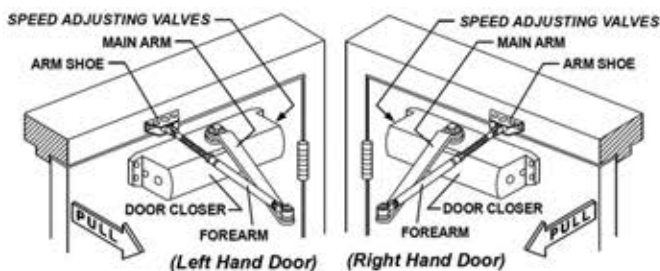



TESTED 50000  
CYCLES



**KZFS-8400 H**  
Double Spring Floor Hinge

### Specification

- General design, suitable for left or right hand to open the door in single and both sides.
- Used low temp. hydraulic oil for any climate operation and constant lubrication.
- Suitable for wooden and toughened glass doors.
- Suitable for door weight from 150kgs.
- Closing force 25nm.
- Suitable for maximum wide door leaf (1000x15000mm).
- Opening angle 90° / 115°

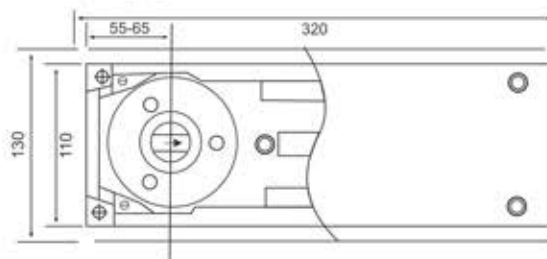

**KZFS-6500**  
Single Spring Floor Hinge

### Specification

- General design, suitable for left or right hand to open the door in single and both sides.
- Used low temp. hydraulic oil for any climate operation and constant lubrication.
- Suitable for wooden and toughened glass doors.
- Suitable for door weight from 60-80kgs.
- Closing force 19nm.
- Suitable for maximum wide door leaf (900x2100mm).
- Opening angle 90° / 115°

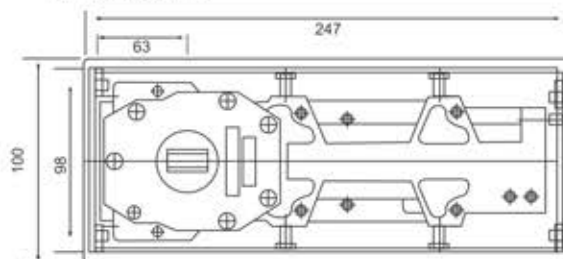
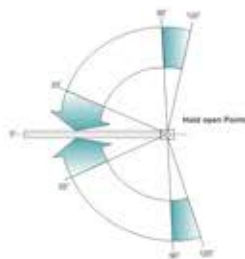

**KZFS-8400**  
Double Spring Floor Hinge

### Specification

- General design, suitable for left or right hand to open the door in single and both sides.
- Used low temp. hydraulic oil for any climate operation and constant lubrication.
- Suitable for wooden and toughened glass doors.
- Suitable for door weight from 80-120kgs.
- Closing force 25nm.
- Suitable for maximum wide door leaf (1200x2400mm).
- Opening angle 90° / 115°

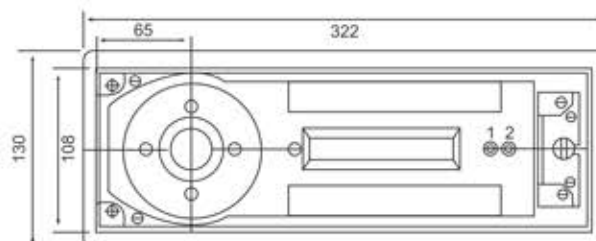
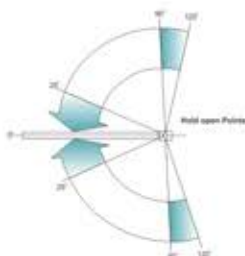



• Satin stainless steel finish • SS 304 cover plates

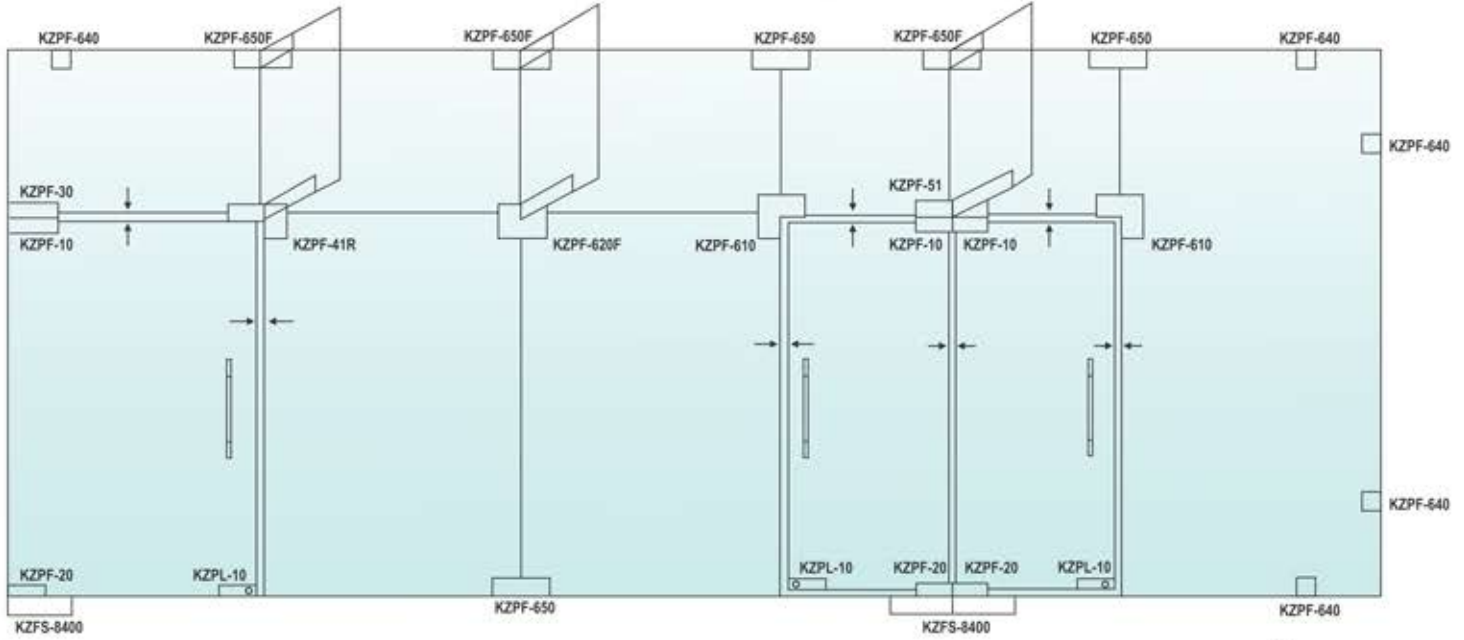

**KZPF-10**  
Top Patch

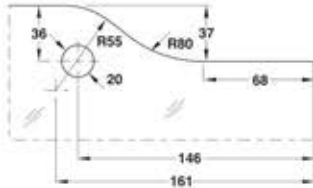

**KZPF-20**  
Bottom Patch

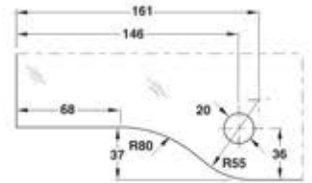

**KZPL-10**  
Corner Patch Lock with Strike Plate

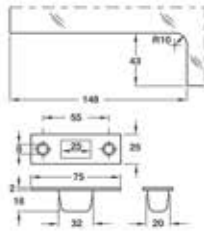

**KZPF-40**  
Over Panel Side Panel Connecting Patch with Pivot (Big L)

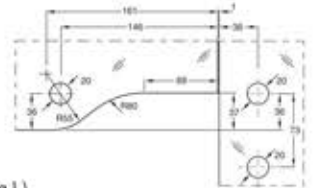

**KZPF-610**  
Over Panel Side Panel Patch Connector (Small L)

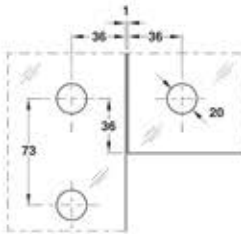

**KZPF-30**  
Wall Mounted Over Panel Patch with Pivot (Over Panel)

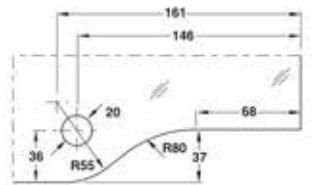

**KZPF-640**  
Wall to Glass Connecting Patch

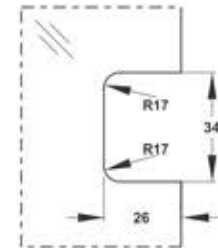

**KZPF-650**  
Glass to Glass Connecting Patch with Wall/Ceiling

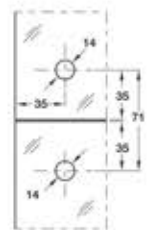

**KZPF-620**  
Square Patch

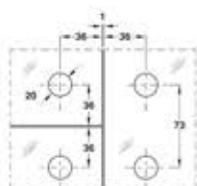

**KZPL-610ST**  
Small L with Stopper

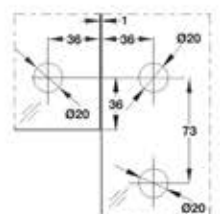



**KZPF-41L**  
Big L with Fin (Left)

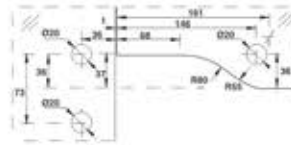
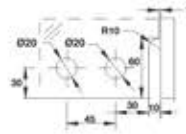

**KZPF-41R**  
Big L with Fin (Right)



**KZPF-51**  
Double Over Panel Patch with Fin

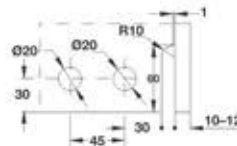

**KZPF-61**  
Double Over Panel Patch

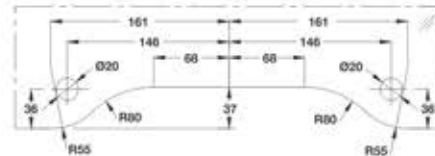

**KZPF-620F**  
Square Patch with Fin

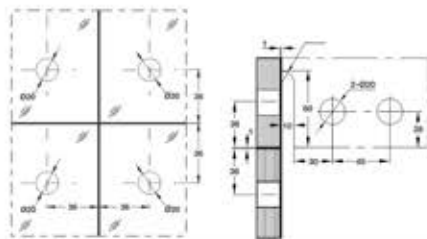

**KZPF-650F**  
Connector with Fin

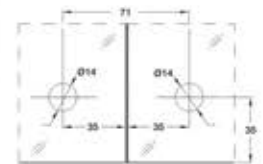

**KZPL-2A**  
Centre Patch Lock

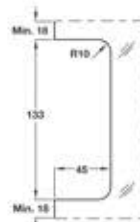

**KZPL-2B**  
Centre Lock Strike Box

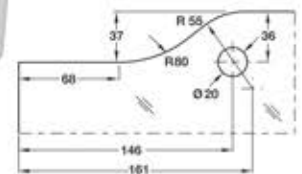

**KZPL-3A**  
Latch Lock



**KZPL-3B**  
Strike Box

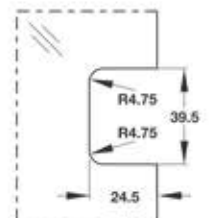

**KZPF-610L/R**  
Triple Glass Patch Connector  
Small with Fin (Left/Right)

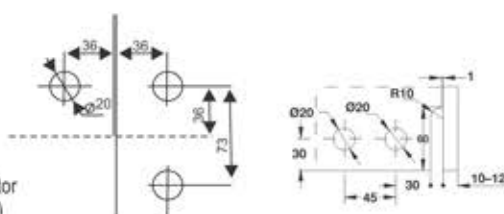

**KZFS-ACC-GDP**  
Top Pivot for Patch Fittings Doors



**KZGDS**  
Glass Door Stopper

• Available finish: Satin stainless steel and PSS • Material: SS, Brass and Zinc



**KZSH-1 H/P**  
Wall to Glass 90° Off Set Hinge

Material : Brass / SS / Zinc  
Glass Thickness : 8mm-12mm  
Weight Cap. : 45kg  
Finish : Matt & Chrome Plated

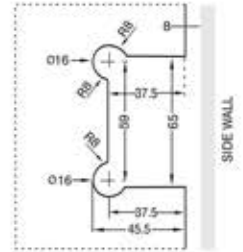

**KZSH-1**  
Wall to Glass 90° Hinge

Material : Brass / SS / Zinc  
Glass Thickness : 8mm-12mm  
Weight Cap. : 45kg  
Finish : Matt & Chrome Plated

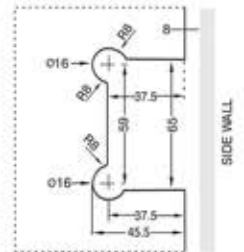

**KZSH-2**  
Glass to Glass 180° Hinge

Material : Brass / SS / Zinc  
Glass Thickness : 8mm-12mm  
Weight Cap. : 45kg  
Finish : Matt & Chrome Plated

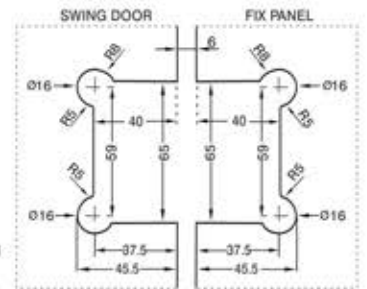

**KZSH-3**  
Glass to Glass 135° Hinge

Material : Brass / SS / Zinc  
Glass Thickness : 8mm-12mm  
Weight Cap. : 45kg  
Finish : Matt & Chrome Plated

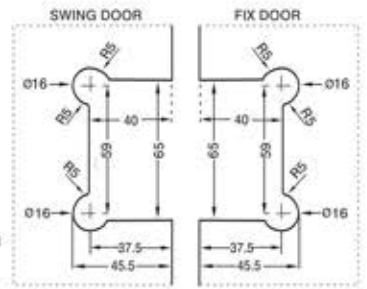

**KZSH-4**  
Glass to Glass 90° Hinge

Material : Brass / SS / Zinc  
Glass Thickness : 8mm-12mm  
Weight Cap. : 45kg  
Finish : Matt & Chrome Plated

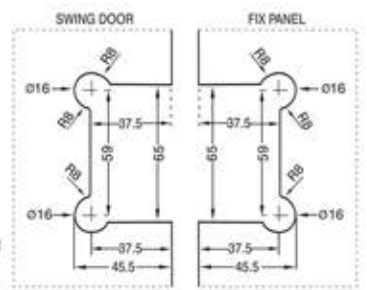

**KZSH-5**  
Wall to Glass 90° Fix Bracket

Material : Brass / SS / Zinc  
Glass Thickness : 8mm-12mm  
Weight Cap. : 45kg  
Finish : Matt & Chrome Plated

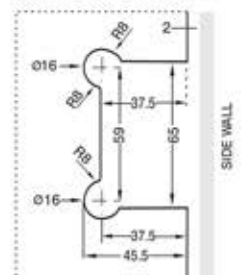



## Regular Series

Material - SS 304

## Premium Series

Material - SS 304

## Exclusive Series

Material - SS 304



**KZGC-1**  
U Connector

Material - SS 304  
Glass Thickness - 8mm-12mm  
Finish - Matt & Chrome Plated  
Product Thickness - 3mm/4mm



**KZGC-11**  
U Connector

Material - SS 304  
Glass Thickness - 8mm-12mm  
Finish - Matt & Chrome Plated  
Product Thickness - 3mm/4mm



**KZGC-111**  
U Connector

Material - SS 304  
Glass Thickness - 8mm-12mm  
Finish - Matt & Chrome Plated  
Product Thickness - 3mm/4mm



**KZGC-2**  
Glass to Glass 135°

Material - SS 304  
Glass Thickness - 8mm-12mm  
Finish - Matt & Chrome Plated  
Product Thickness - 3mm/4mm



**KZGC-22**  
Glass to Glass 135°

Material - SS 304  
Glass Thickness - 8mm-12mm  
Finish - Matt & Chrome Plated  
Product Thickness - 3mm/4mm

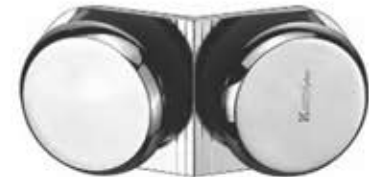

**KZGC-222**  
Glass to Glass 135°

Material - SS 304  
Glass Thickness - 8mm-12mm  
Finish - Matt & Chrome Plated  
Product Thickness - 3mm/4mm



**KZGC-3**  
Glass to Glass 90°

Material - SS 304  
Glass Thickness - 8mm-12mm  
Finish - Matt & Chrome Plated  
Product Thickness - 3mm/4mm



**KZGC-33**  
Glass to Glass 90°

Material - SS 304  
Glass Thickness - 8mm-12mm  
Finish - Matt & Chrome Plated  
Product Thickness - 3mm/4mm



**KZGC-333**  
Glass to Glass 90°

Material - SS 304  
Glass Thickness - 8mm-12mm  
Finish - Matt & Chrome Plated  
Product Thickness - 3mm/4mm



**KZGC-4**  
L Connector

Material - SS 304  
Glass Thickness - 8mm-12mm  
Finish - Matt & Chrome Plated  
Product Thickness - 3mm/4mm



**KZGC-44**  
L Connector

Material - SS 304  
Glass Thickness - 8mm-12mm  
Finish - Matt & Chrome Plated  
Product Thickness - 3mm/4mm



**KZGC-444**  
L Connector

Material - SS 304  
Glass Thickness - 8mm-12mm  
Finish - Matt & Chrome Plated  
Product Thickness - 3mm/4mm



**KZGC-5**  
Glass to Glass 180°

Material - SS 304  
Glass Thickness - 8mm-12mm  
Finish - Matt & Chrome Plated  
Product Thickness - 3mm/4mm



**KZGC-55**  
Glass to Glass 180°

Material - SS 304  
Glass Thickness - 8mm-12mm  
Finish - Matt & Chrome Plated  
Product Thickness - 3mm/4mm



**KZGC-555**  
Glass to Glass 180°

Material - SS 304  
Glass Thickness - 8mm-12mm  
Finish - Matt & Chrome Plated  
Product Thickness - 3mm/4mm



**KZGC-6**  
T-Connector Glass to Glass 90°

Material - Stainless Steel 304  
Door Thickness - 8mm-12mm  
Finish - Matt & Chrome Plated  
Product Thickness - 4mm  
Suitable for holding 3 glasses together

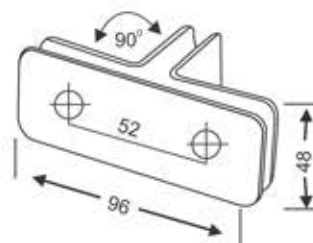

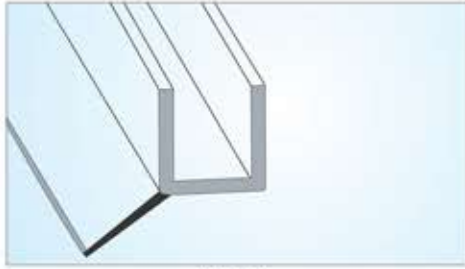

**KZPS-01**  
For : 8/10/12mm Glass  
Size : 2.2mtr / 2.5mtr

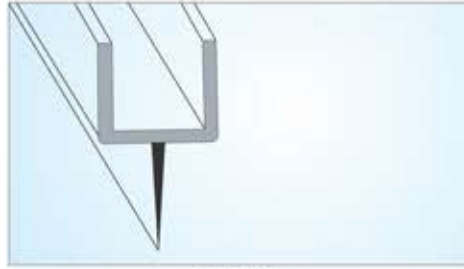

**KZPS-02**  
For : 8/10/12mm Glass  
Size : 2.2mtr / 2.5mtr



**KZPS-03**  
For : 8/10/12mm Glass  
Size : 2.2mtr / 2.5mtr



**KZPS-04**  
For : 8/10/12mm Glass  
Size : 2.2mtr / 2.5mtr



**KZPS-05**  
For : 8/10/12mm Glass  
Size : 2.2mtr / 2.5mtr

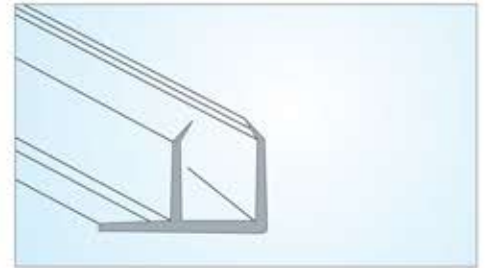

**KZPS-06**  
For : 8/10/12mm Glass  
Size : 2.2mtr / 2.5mtr



**KPS-07**  
For : 8/10/12mm Glass  
Size : 2.2mtr / 2.5mtr



## Magnetic Profiles

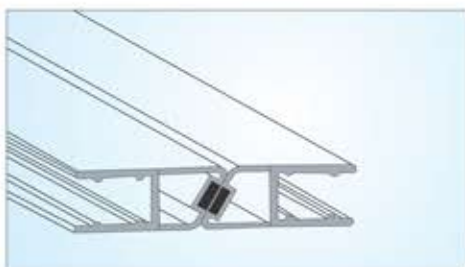

**KZPS-M1 180°**  
For : 8/10/12mm Glass  
Size : 2.2mtr / 2.5mtr



**KZPS-M2 135°**  
For : 8/10/12mm Glass  
Size : 2.2mtr / 2.5mtr

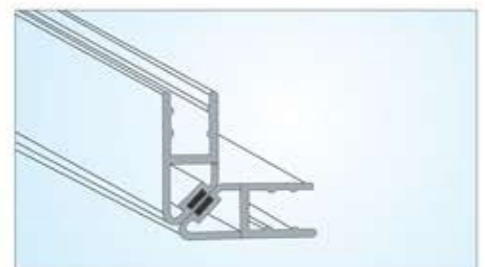

**KZPS-M3 90°**  
For : 8/10/12mm Glass  
Size : 2.2mtr / 2.5mtr



Ø19mm/25mm



**KZKH-1**  
Wall to Rod  
(Dia 19mm/25mm)

Ø19mm/25mm



**KZKH-2**  
Rod to Glass  
(Dia 19mm/25mm)



Ø19mm/25mm

**KZKH-3**  
Rod to Rod  
(Dia 19mm/25mm)

Ø19mm/25mm



**KZKH-4**  
Rod to Glass  
(One Side Blind)



Ø19mm/25mm

**KZKH-5**  
Rod to Rod T Connector  
(Dia 19mm/25mm)



Ø19mm

**KZKH-ACC-19**  
Reinforcing Rod (Dia 19mm)

## Canopy Fitting



**KZCF-1**  
Wall to Glass Connector

**Specification**

- Finish : Satin stainless steel (SSS)
- Suitable for canopies in interior & exterior
- Stainless steel 304 grade
- To fix glass with the wall
- Adjustable angle
- Washer to prevent glass from damage

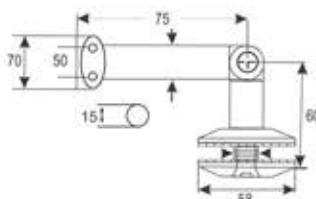

**KZCF-2**  
Rod to Glass Connector

**Specification**

- Finish : Satin stainless steel (SSS)
- Suitable for holding canopy glass with rod along with wall to rod
- Stainless steel 304 grade
- To hold canopy glass with rod
- Adjustable angle
- Washer to prevent glass from damage

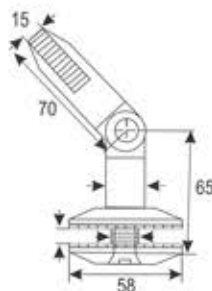

**KZCF-3**  
Wall to Rod Connector

**Specification**

- Finish : Satin stainless steel (SSS)
- Suitable for holding wall to rod with wall
- Stainless steel 304 grade
- To hold rod with the wall
- Adjustable angle
- Washer to prevent glass from damage

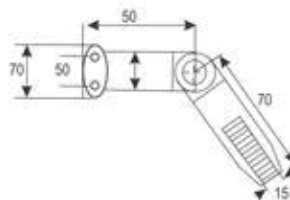

**KZCF-ROD (16mm)**  
Canopy Rod with Thread



**KZSL-44-A1**  
Roller (S.S.)

**Specification**

- Four fiber reinforced plastic rollers of 30 mm diameter
- Stainless Steel Grade 304 glass holding point
- Height adjustable glass holding points (10 mm)
- Secure grip for the door
- Self aligning suspension of door
- Roller configuration for even distribution of load
- Independently connected rollers to prevent damage to track and rollers
- Suitable for 10 mm or 12 mm glass
- Suitable for door weight 40 kg.

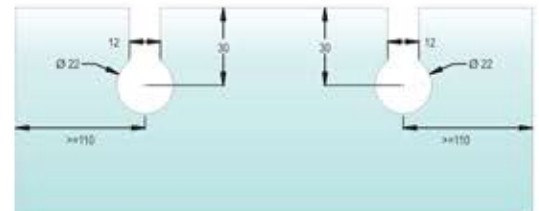

CUTOUT DETAILS OF CSL-44-A1



**KZSL-44-A2**  
Roller (Brass)

**Specification**

- Heavy duty sliding door roller
- Suitable for up to a door weight of 80 Kg
- Larger surface area for secure grip of the door
- Adjustable threaded rod for installation perfection
- Solid brass for glass holding

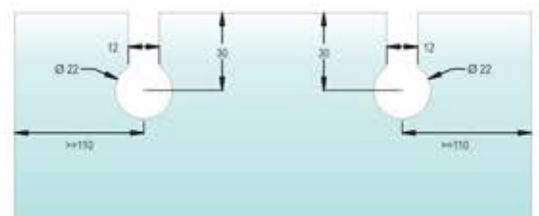

CUTOUT DETAILS OF CSL-44-A2



**KZSL-44-R8**  
8 Wheel Rectangular Roller (SS)

**Specification**

- Material : Stainless steel 304 grade
- Finish : Satin stainless steel (SSS)

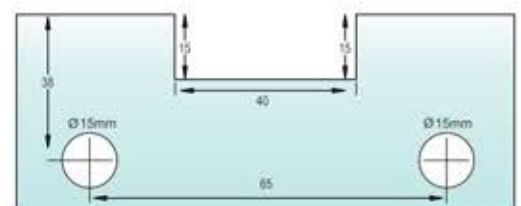

CUTOUT DETAILS OF CSL-44-R8





**KZSL-44-A3**  
Stopper



**KZSL-44-A5**  
Wall to Track Clamp



**KZSL-44-A6**  
Glass to Track Clamp



**KZSL-HN-50**  
Sliding Handle (Dia 50mm)



**KZSL-HN-60**  
Sliding Handle (Dia 60mm)



**KZSL-44G**  
Floor Guide



**KZSL-44-A9**  
Wall to Track Connector



**KZSDL-13A+13C**  
Sliding Door Lock with Strike Plate



**KZSDL-13A**  
Sliding Door Lock



**KZSDL-13B**  
Strike Box



**KZSDL-13D**  
Strike Box For Over Lap Glass



**KZSL-44-B1**  
Aluminium Track (Single)  
Available in 8, 10 & 13 Ft.

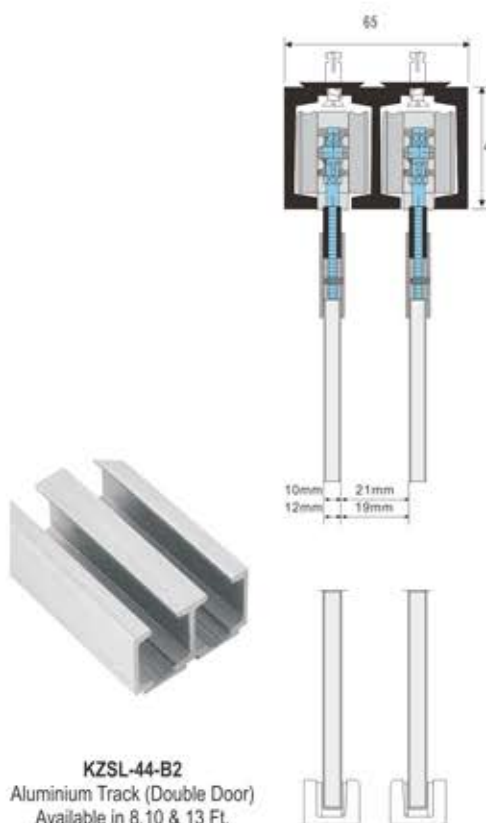

**KZSL-44-B2**  
Aluminium Track (Double Door)  
Available in 8, 10 & 13 Ft.

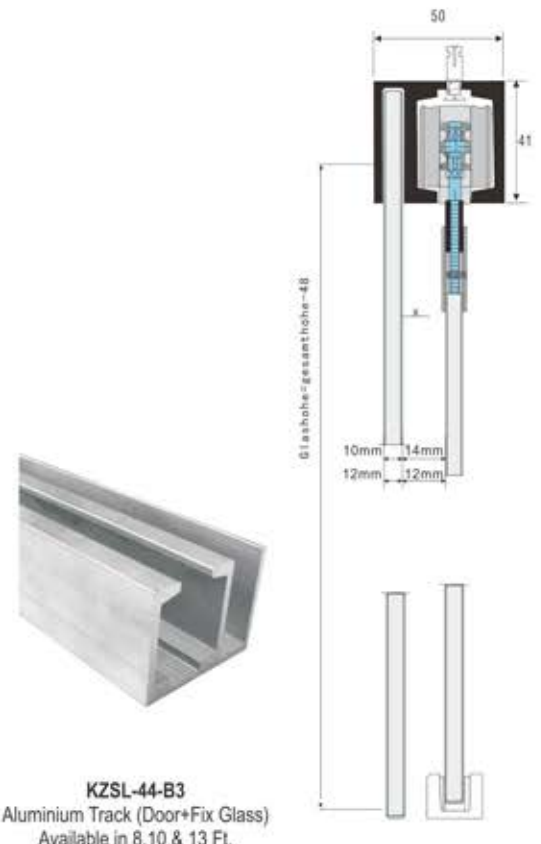

**KZSL-44-B3**  
Aluminium Track (Door+Fix Glass)  
Available in 8, 10 & 13 Ft.



**KZSL-11A**  
Shower Sliding Roller

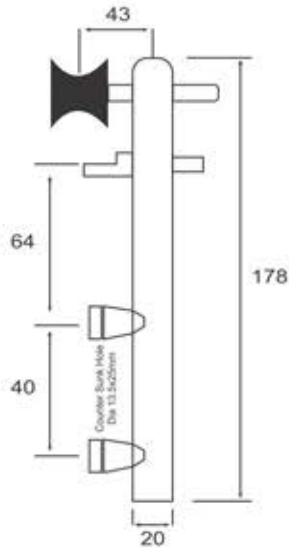

**Specification**  
 • Material : Stainless steel 304 grade  
 • Finish : Polish stainless steel (PSS)  
 • Available with countersunk hole



**KZSL-11B**  
Wall to Glass Connector



**KZSL-11C**  
Wall to Glass Connector with Stopper



**KZSL-11E**  
Wall to Rod Holder (Dia 25mm)



**KZSL-11F**  
Glass to Rod Holder



**KZSL-11G**  
Floor Guide



**KZSL-11I**  
Stopper



**KZSL-11H**  
Rod to Rod Holder (Dia 25mm)



**KZSL-11 OHS**  
Stopper with Over Head Support



**KZSL-11 SB**  
Stopper with Bumper



**KZSL-ACC-25**  
Shower Sliding Pipe



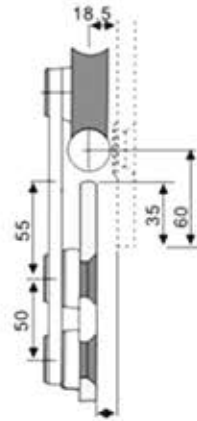

13.5 / 10mm  
11.5 / 12mm



**KZSL-22A**  
Office Sliding Roller (Flat Type)



**KZSL-33A**  
Office Sliding Roller (Round Type)



**KZSL-33-TH**  
Wall to Rod Clamp



**KZSL-33-TH-G2**  
Glass to Rod Clamp



**KZSL-33G**  
Floor Guide



**KZSL-33B**  
Door Stopper



**KZSL-33-TH-WL**  
Wall to Rod Holder



**KZSL-33H**  
Glass to Glass Connector 180°



**KZSL-ACC-25**  
Shower Sliding Pipe



**KZSL-11-A1**  
Roller



**KZSL-11-A2**  
Track to Glass Holder



**KZSL-11-A3**  
Stopper



**KZSL-11-A4**  
Floor Guide



**KZSL-11-A5**  
Wall to Track Connector



**KZSL-11-A6**  
Track to Track Connector 90°



Ø 10mmx30mm

**KSL-11-Track**  
Shower Sliding Track  
(Available in 1.5 Mt, 1.8 Mt & 2.1 Mt)

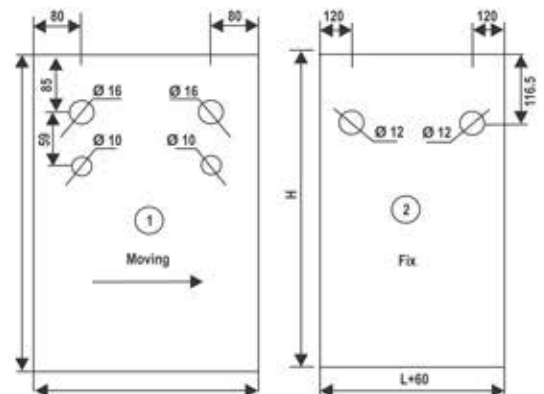
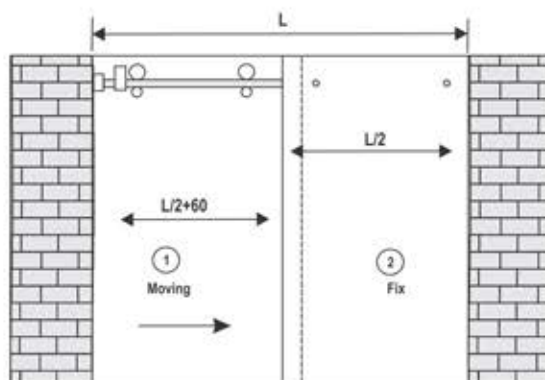



# Sliding Folding System



Two Way Open



One Way Open

**Specification**

• Track for sliding folding door system to be mounted to the ceiling and floor

**Note :-**

- Maximum weight per door : 70kg
- Maximum width per door : 900mm
- Maximum height per door : 2500mm
- Suitable for 8 to 10mm glass thickness



**KZSFS-1**  
Fixed Hinge



**KZSFS-2**  
Glass to Glass Center Hinge



**KZSFS-3**  
Center Hinge with Roller



**KZSFS-4**  
End Hinge with Roller



**KZSFS-5**  
Floor Fixed Hinge



**KZSFS-6 (Left /Right)**  
Glass to Glass Center Hinge with Lock



**KZSFS-7**  
Glass to Glass Center Hinge with Guide



**KZSFS-8**  
End Hinge with Guide



**KZSFS-9**  
Wall to Glass Hinge



**KZSFS-10**  
Floor Track Bottom (S.S.)



**KZSFS-11**  
Aluminium Track (Top)

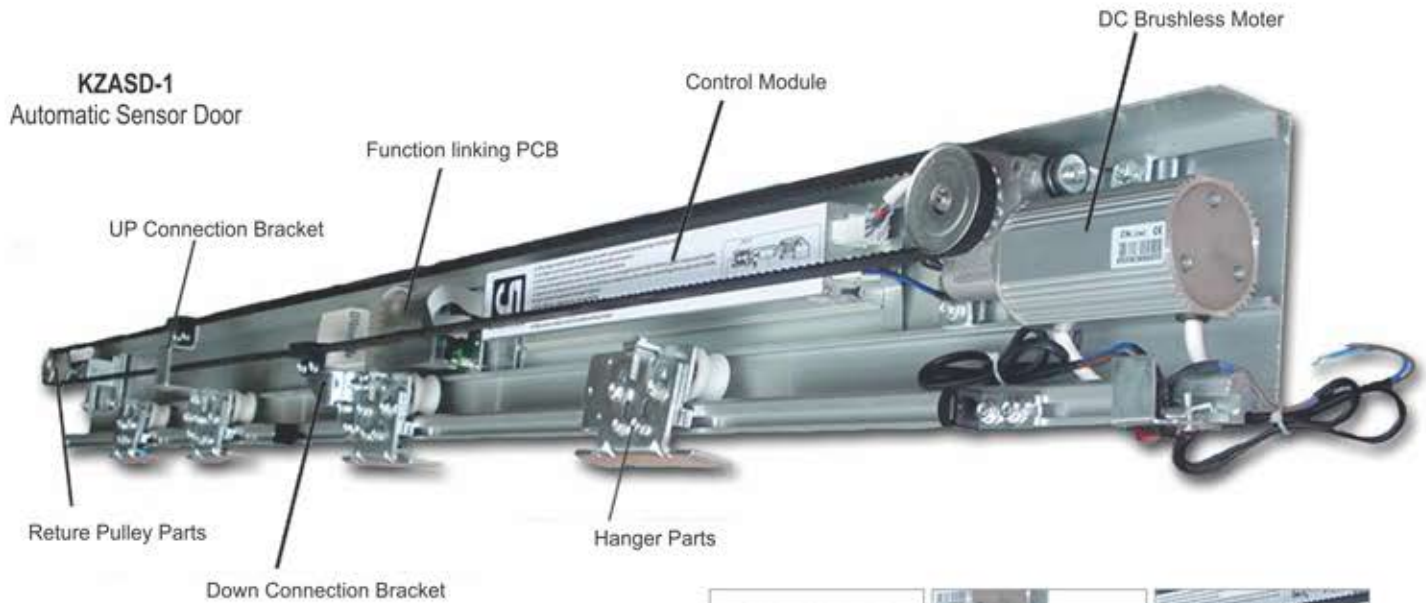

### Specification

Door Parameter	
Single Leaf Maximum Opening	1200mm x 2400mm
Bi-parting Door Maximum Opening	2200mm x 2400mm
Maximum Door Weight Single Leaf	75kg to 90kg (Single Door)
Maximum Door Weight Double Leaf	75kg x 2 Door (Bi-parting)

### AUTOMATIC DOOR PARAMETER

TYPE	CASD-1
Opening Speed	Adjust Between 250-600mm/Sec.
Closing Speed	Adjust Between 150-300mm/Sec.
Holding Time	1-15 Sec.
Pushing Force	<37N      <45N
Power	Ac 200-250V
Voltage	DC 24V-50W
Environment Temperature	-200C - +500C



### Features and advantages

- Intelligent control system.
- Drive equipment with low noise.
- Advanced brush less motor and worm wheel reducer are integrated.
- Special self-locking function without any addition components.
- With different triggered opening modes.
- Double door interlock function.
- Optional power supply backup to ensure the normal operation.
- When door is closed, it shall be locked and kept closed.
- Apply to doors for garage, usage of anti-radiation for hospitals, warehouses, science and technology factories, barrier-free space, commercial building, shopping mall, etc.
- Easy installation & low maintenance.
- Track size : 4200mm/6400mm.







**KZLK-1**  
Double Door Lock (Only Key)



**KZLK-2**  
Single Door Lock (Only Key)



**KZLK-3**  
Double Door Lock (Key & Knob)



**KZLK-4**  
Single Door Lock (Key & Knob)



**KZLK-5**  
Double Door Lock



**KZLK-6**  
Single Door Lock



**KZLK-7**  
Double Door Lock (Push Button)



**KZLK-8**  
Single Door Lock (Push Button)



**KZLK-9**  
Double Door Lock (Only Knob)



**KZLK-10**  
Single Door Lock (Only Knob)



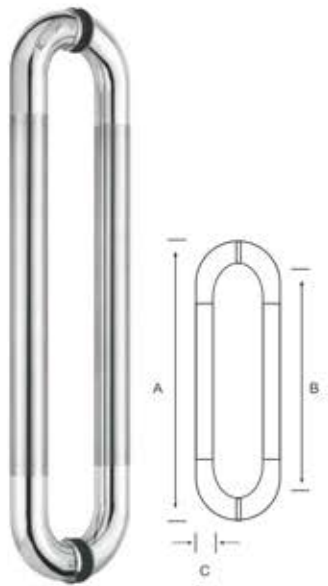

**KZDH-11**

Overall Length (A)	Centre to Centre Hole (B)	Diameter (C)
327	302	25
450	420	25
482	450	32
600	568	32

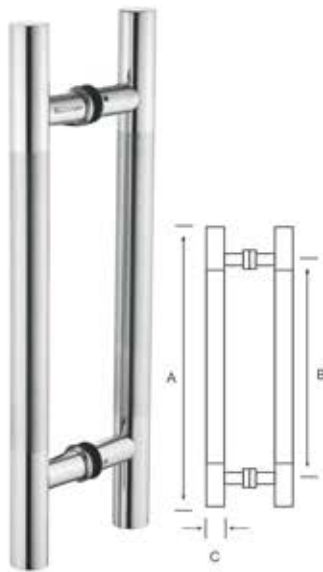

**KZDH-55**

Overall Length (A)	Centre to Centre Hole (B)	Diameter (C)
325	240	25
600	455	25
457	302	32
600	454	32
600	480	32
900	600	32
900	700	32
1200	900	32

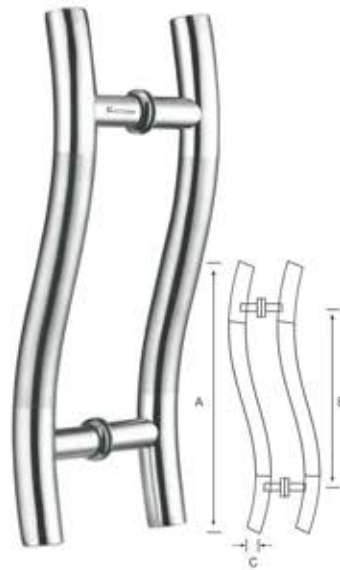

**KZDH-77**

Overall Length (A)	Centre to Centre Hole (B)	Diameter (C)
350	250	25
457	302	32
600	420	32

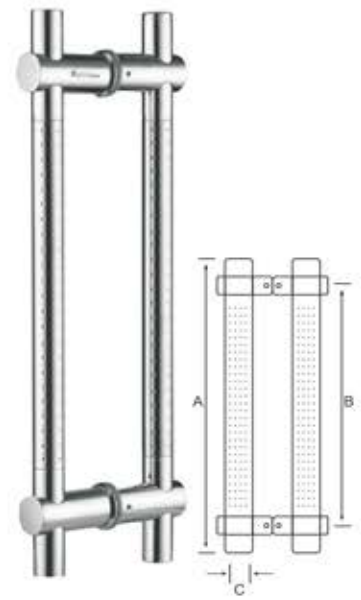

**KZDH-55 (Adjustable)**

Overall Length (A)	Centre to Centre Hole (B)	Diameter (C)
325	200	25
457	302	32
600	450	32

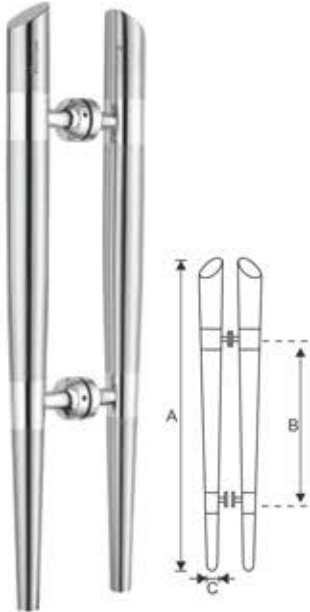

**KZDH-99**

Overall Length (A)	Centre to Centre Hole (B)	Diameter (C)
457	302	38
600	450	38



**KZDH-WSS-11**

Overall Length (A)	Centre to Centre Hole (B)	Diameter (C)
350	280	15/30
450	302	25/45
550	454	25/45



**KZDH-WSS-22**

Overall Length (A)	Centre to Centre Hole (B)	Diameter (C)
450	302	38/25
600	454	38/25

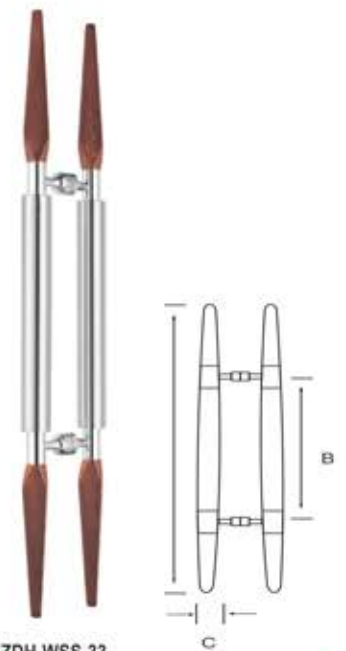

**KZDH-WSS-33**

Overall Length (A)	Centre to Centre Hole (B)	Diameter (C)
500	302	38
850	430	38

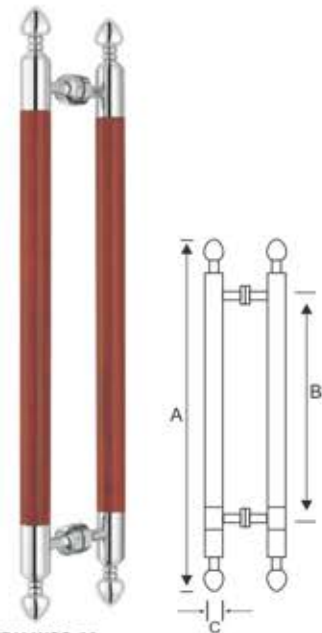

**KZDH-WSS-66**

Overall Length (A)	Centre to Centre Hole (B)	Diameter (C)
500	302	38

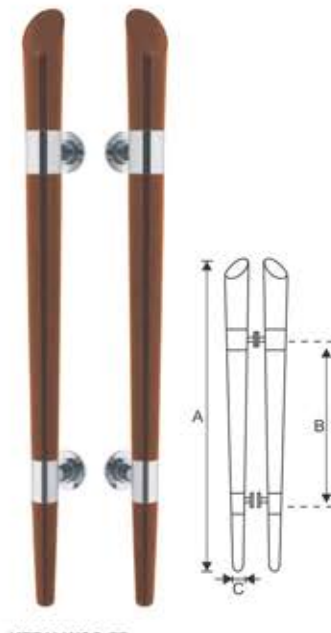

**KZDH-WSS-77**

Overall Length (A)	Centre to Centre Hole (B)	Diameter (C)
500	302	38

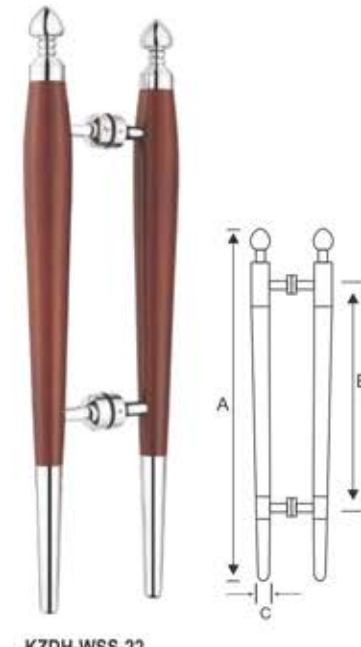

**KZDH-WSS-22**

Overall Length (A)	Centre to Centre Hole (B)	Diameter (C)
500	300	38

## Door Handle with Lock

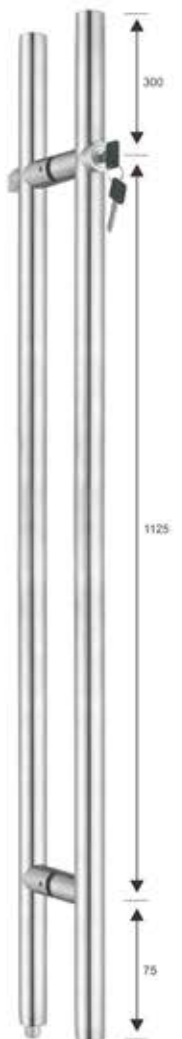

**KZDHL-55**  
Size : 35x1500mm

## Shower Handles



**KZDH-TB-01**  
Sizes : 19x152x457CC  
25x152x457CC



**KZDH-TB-02**  
Sizes : 15/30x152x457CC



(Available in 200mm & 220mm Arm Distance)



## Spider with Fin

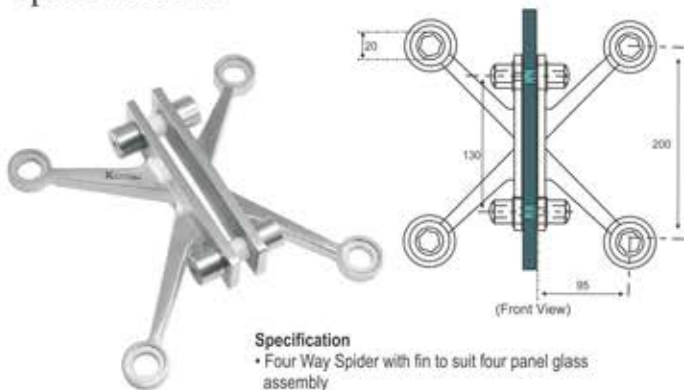

**KZSP-A4**  
Four Way Spider

**Specification**

- Four Way Spider with fin to suit four panel glass assembly
- Material : Stainless Steel 316 Grade
- With gasket & Teflon washers to prevent glass from damage
- Hold glass with the help of articulated/fix routels



**KZSP-A44**  
Two Way Spider (Wall Mounted)

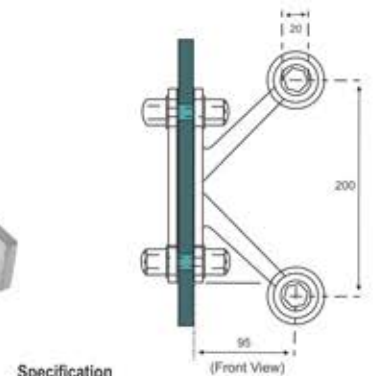

**Specification**

- Two Way Spider with fin to suit two panel wall assembly
- Material : Stainless Steel 316 Grade
- With gasket & teflon washers to prevent glass from damage
- Hold glass with the help of articulated/fix routels

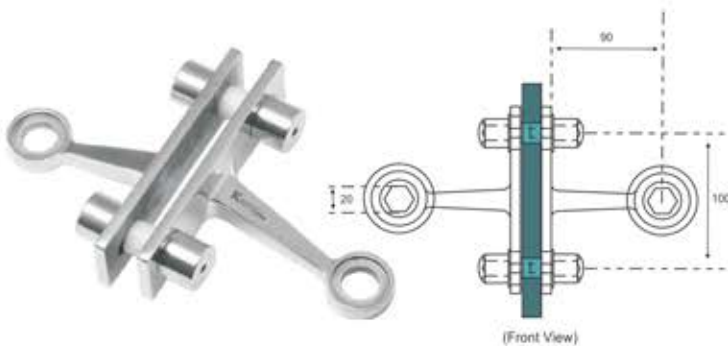

**KZSP-A2**  
Two Way Spider

**Specification**

- Two Way Spider with fin to suit two panel glass assembly
- Material : Stainless Steel 316 Grade
- With gasket & teflon washers to prevent glass from damage
- Hold glass with the help of articulated/fix routels



**KZSP-A22**  
One Way Spider (Wall Mounted)

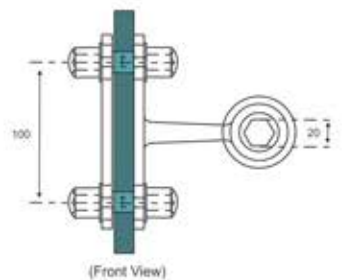

**Specification**

- One Way Spider with fin to suit one panel wall assembly
- Material : Stainless Steel 316 Grade
- With gasket & Teflon washers to prevent glass from damage
- Hold glass with the help of articulated/fix routels

Please refer to actual product for hole preparation. Customized solutions can be provided according to the requirements of the project. (Spider, Fin / Splice Plates & Routels)



(Available in 200mm & 220mm Arm Distance)

## Spider without Fin



**KZSP-B1**

One Way Spider without Fin (156 mm Arm)

**Specification**

- 160 mm arm
- One Way Spider without fin to hold the glass at one point
- Material : Stainless Steel 304 Grade
- Hold glass with the help of articulated/fix routels.
- Designed to hold with fix structure

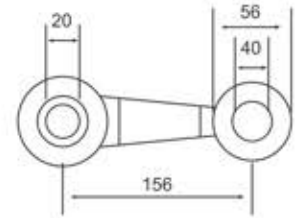

**KZSP-B2 (90°)**

Two Way Spider 90° without Fin

**Specification**

- Two Way Spider without fin to hold two glass panels at 90° with fixed structure.
- Material : Stainless Steel 304 Grade
- Hold glass with the help of articulated/fix routels.
- Designed to hold with fix structure

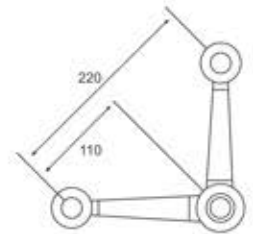

**KZSP-B2 (180°)**

Two Way Spider 180° without Fin

**Specification**

- 220 mm arm
- Two Way Spider without fin to hold two glass panels at 180° with fixed structure.
- Material : Stainless Steel 304 Grade
- Hold glass with the help of articulated/fix routels.
- Designed to hold with fix structure

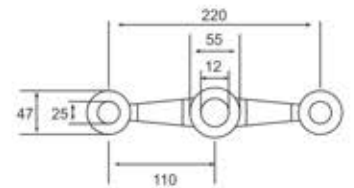

**KZSP-B3**

Three Way Spider without Fin

**Specification**

- Three Way Spider without fin to hold three glass panels
- Material : Stainless Steel 304 Grade
- Hold glass with the help of articulated/fix routels.
- Designed to hold with fix structure

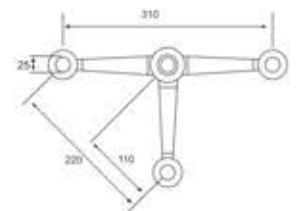

**KZSP-B4**

Four Way Spider without Fin

**Specification**

- Four Way Spider without fin to hold four glass panel together with fixed structure
- Material : Stainless Steel 304 Grade
- Hold glass with the help of articulated/fix routel.
- Designed to hold with fix structure

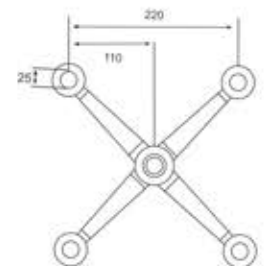

**KZSP-B4 (90°)**

Four Way Spider without Fin (90°)

**Specification**

- Four Way Spider without fin 900 to hold four glass panel together with fixed structure
- Material : Stainless Steel 304 Grade
- Hold glass with the help of articulated/fix routel
- Designed to hold with fix structure

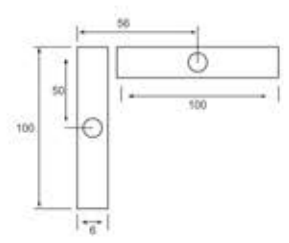
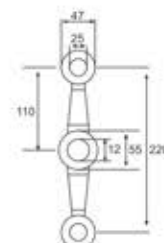

Please refer to actual product for hole preparation. Customized solutions can be provided according to the requirements of the project. (Spider, Fin / Splice Plates & Routels)

## Designer Spider Fittings \*Cutout Details on Request



**KZSP-1**

One Way Spider for Fix Structure/Wall

**Specification**

- One point holding of fin with each part to hold
- Finish : Satin Stainless Steel (SSS)
- Material : Stainless Steel 304 Grade
- With teflon washers to prevent glass from damage



**KZSP-2**

Two Way Spider for Fix Structure/Wall

**Specification**

- Two point holding of fin with each part to hold
- Finish : Satin Stainless Steel (SSS)
- Material : Stainless Steel 304 Grade
- With teflon washers to prevent glass from damage



**KZSP-4**

Four Way Spider with Fin

**Specification**

- Four point holding of fin with each part to hold
- Finish : Satin Stainless Steel (SSS)
- Material : Stainless Steel 304 Grade
- With teflon washers to prevent glass from damage



**KZSP-5**

Four Way Spider for 90° Corner  
(Two Glass Joints 90°)

**Specification**

- Four point holding of fin with each part to hold
- Finish : Satin Stainless Steel (SSS)
- Material : Stainless Steel 304 Grade
- With teflon washers to prevent glass from damage

## Fin Plates



**KZFP-200**

Fin Plate (200mm)

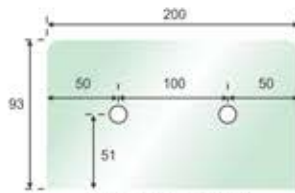

**Specification**

- Two point holding of fin
- Finish : Satin Stainless Steel (SSS)
- Material : Stainless Steel 304 Grade
- With teflon washers to prevent glass from damage



**KZFP-300**

Fin Plate (300mm)

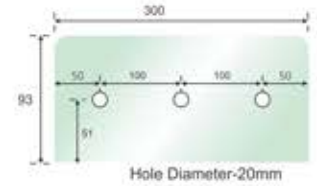

**Specification**

- Three point holding of fin
- Finish : Satin Stainless Steel (SSS)
- Material : Stainless Steel 304 Grade
- With teflon washers to prevent glass from damage



**KZFP-350**

Fin Plate (350mm)

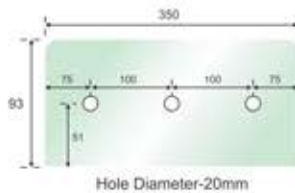

**Specification**

- Three point holding of fin
- Finish : Satin Stainless Steel (SSS)
- Material : Stainless Steel 304 Grade
- With teflon washers to prevent glass from damage



**KZFP-400**

Fin Plate (400mm)

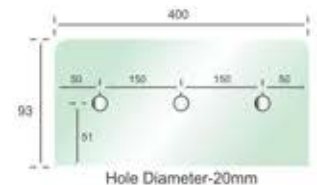

**Specification**

- Three point holding of fin
- Finish : Satin Stainless Steel (SSS)
- Material : Stainless Steel 304 Grade
- With teflon washers to prevent glass from damage

## Splice Plates



**KZSP-200**

Splice Plate (200mm)

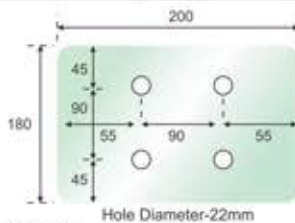

**Specification**

- Two point holding with each fin part
- Finish : Satin Stainless Steel (SSS)
- Material : Stainless Steel 304 Grade
- With teflon washers to prevent glass from damage



**KZSP-250**

Splice Plate (250mm)

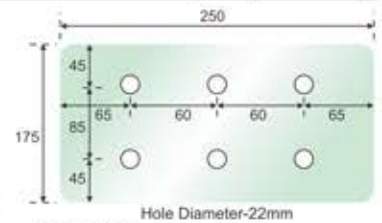

**Specification**

- Three point holding with each fin part
- Finish : Satin Stainless Steel (SSS)
- Material : Stainless Steel 304 Grade
- With teflon washers to prevent glass from damage



**KZSP-300**

Splice Plate (300mm)

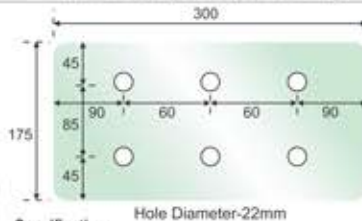

**Specification**

- Three point holding with each fin part
- Finish : Satin Stainless Steel (SSS)
- Material : Stainless Steel 304 Grade
- With teflon washers to prevent glass from damage



**KZSP-350**

Splice Plate (350mm)

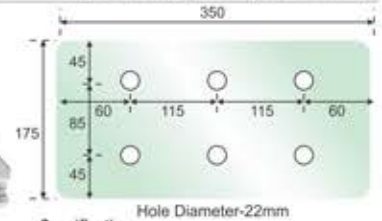

**Specification**

- Three point holding with each fin part
- Finish : Satin Stainless Steel (SSS)
- Material : Stainless Steel 304 Grade
- With teflon washers to prevent glass from damage



**KZSP-AFB 36FL**  
Articulated Routel (Flat Head)



**Specification**

- Articulated flat head routel to be used along with spiders to hole glass
- Material : Stainless Steel 304 Grade
- With teflon washers to prevent glass from damage
- Adjustable upto 15mm glass thickness

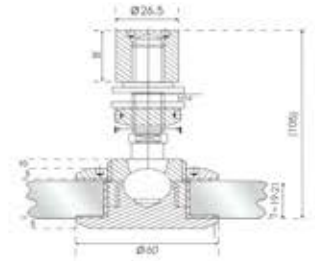

**KZSP-AFB 36CS**  
Articulated Routel (Counter Sunk Hole)

**Specification**

- Articulated Counter Sunk routel to be used along with spiders to hole glass
- Material : Stainless Steel 304 Grade
- With teflon washers to prevent glass from damage
- Adjustable upto 15mm glass thickness

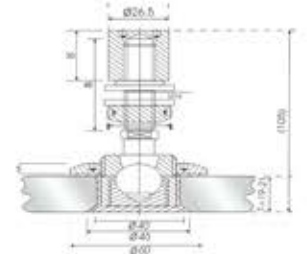
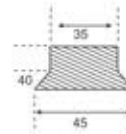

**KZSP-AFB CS**  
Fixed Routel (Counter Sunk)

**Specification**

- Countersunk head routel to be used along with spiders to hold glass
- Material : Stainless Steel 304 Grade
- With teflon washers to prevent glass from damage

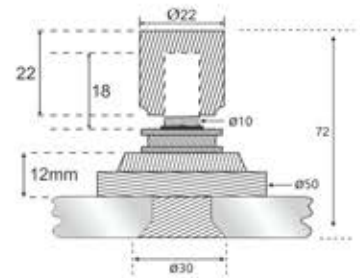
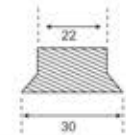

**KZSP-AFB FL**  
Fixed Routel (Flat Head)

**Specification**

- Fixed flat head routel to be used along with spiders to hold glass
- Material : Stainless Steel 304 Grade
- With teflon washers to prevent glass from damage
- Adjustable to glass thickness
- Smaller in sizes

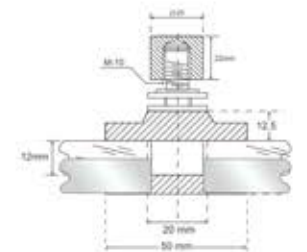

**KZSP-RB (FH/CS)**  
Rigid Bolt (Flat Head/Counter Sunk)

**Specification**

- Rigid Bolt to be used along with spiders to hole glass
- Material : Stainless Steel 304 Grade
- With teflon washers to prevent glass from damage
- Adjustable upto 15mm glass thickness

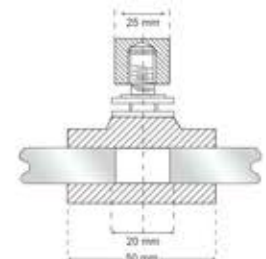

**KZSP-1A-01**  
Iron Assembly

**Specification**

- Fixing bolt helps to hold without fin spiders with fix structure
- Material : Stainless Steel 304 Grade
- Adjustable height for accurate fixing of pider with flat head

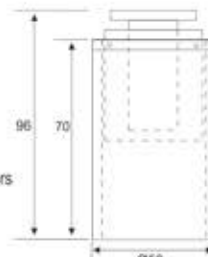

**CSP-FBM**  
Fixed Bolt (Mini)







**KZRA-1**  
Spigot



**KZRA-2**  
Spigot



**KZRA-3**  
Spigot



**KZRA-5**  
Wall to Handrail



**KZRA-6**  
(Glass to Handrail)



**KZRA-8 (Flat)**  
U Shape Railing Connector



**KZRA-8 A (Curve)**  
U Shape Railing Connector



**KZRA-9**  
Railing Stud & Fastener



**KZRA-10**  
(Single Slotted Round Pipe)  
Available in 6mtr. Length



**KZRA-11**  
(Double Slotted Round Pipe)  
Available in 6mtr. Length



**KZRA-12**  
(Single Slotted Curve Pipe)  
Available in 6mtr. Length



**KZRA-13**  
(Single Slotted Square Pipe)  
Available in 6mtr. Length



**KZRA-14**  
(Slotted Pipe Joints 180°)



**KZRA-15**  
(Slotted Pipe Joints 90°)



**KZRA-16**  
(Slotted Pipe Joints L-Type 90°)



**KZRA-17**  
(Straight Joints)



**KZRA-18**  
(Wall to Slotted Pipe Joints)



**KZRA-19**  
(Slotted Pipe End Caps)

## Door Knobs



**KZDK-1**  
Door Knob



**KZDK-2**  
Door Knob



**KZDK-3**  
Door Knob

## Glass Lifter



**KZGL-2C**  
Glass Lifter with Two Cups



**KZGL-3C**  
Glass Lifter with Three Cups







**Kazma**<sup>TM</sup>*plus*  
WORLD OF ARCHITECTURAL INNOVATION  
e-mail : [kazmainternational@gmail.com](mailto:kazmainternational@gmail.com)

